

Scaffold Accessories & Specials

Available in Painted & Galvanised Finish



Swivel Jacks

Code: SWLJ
 Size: 34 x 650 MM
 Weight: 6.9 kg



Solid U Head Jacks

Code: USJ
 Size: 34 x 650 mm
 Weight: 8.9 kg



Plain Base Plates

Code: PBP
 Size: 8.0X150 mm SQ
 Weight: 1.8 kg

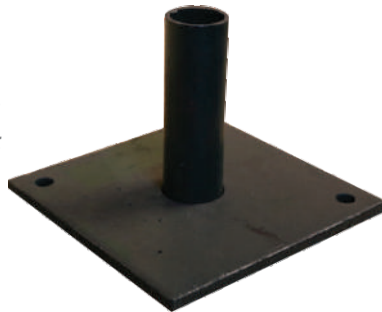

CC Couplers

Code: CCC
 Weight: 1.5 kg



Topper

Code: Topper
 Size: 0.3 m
 Weight: 3 kg



Toe Board Brackets

Code: TBB
 Weight: 0.85 kg



Toe Board Couplers

Code: TBC
 Weight: 1.45 kg



End Toe Board Bracket

Code: ETBB
 Weight: 1 kg



Ladder Access Transoms

Code:	0.7MLAT	1.2MLAT	1.8MLAT	2.4MLAT
Size:	0.7 m	1.2 m	1.8 m	2.4 m
Weight:	5.3 kg	7.5 kg	13.2 kg	16.5 kg



* Special sizes are made per request

Corner Panels

Code:	1X1ICF	2X1ICF	2X2ICF	3X2GICF
Size:	1 x 1	2 x 1	2 x 2	3 x 2
Weight:	4 kg	7.2 kg	11.4 kg	10.5 kg

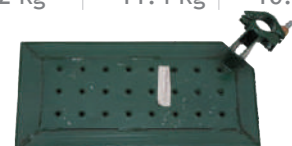

*Pictures are for illustrative purpose only, weight of product may vary.

Visit www.turboscaffolding.com.au

Scaffold Accessories & Specials

Available in Painted & Galvanised Finish



Two Board Hopup Intermediate

Code: 2BHBCPLR
Size: 2 Board
Weight: 7.5 kg



Three Board Hopups with Spigot

Code: 3BHBS
Size: 3 Board
Weight: 12.1 kg



Two Board Hopups with Spigot

Code: 2BHBS
Size: 2 Board
Weight: 7.3 kg



Galvanised One Board Hopup with Coupler

Code: 1GBHBCPLR
Size: 1 Board
Weight: 2.8 kg

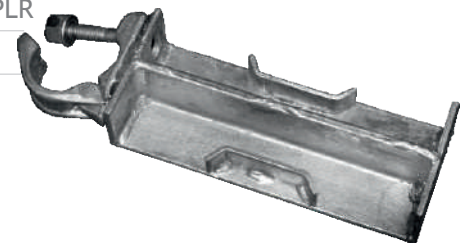

Steel Sole Boards

Code: SSB
Size: 0.5 m
Weight: 5.5 kg



Ginny Wheels

Code: GW
Size: 200 mm
Weight: 4.5 kg



Ladder Access Hatch Door

Code: LAHD
Size: 0.8 X 0.6 m
Weight: 9.8 kg

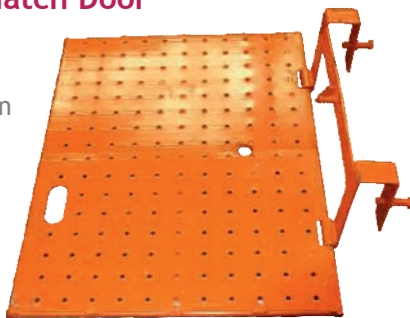

Edge Protection Standards

Code: 1.2MEPSTD
Size: 1.2 m
Weight: 8.9 kg



Board Restraints

Code:	0.7MBRS	1.2MBRS	1.8MBR
Size:	0.7 m	1.2 m	1.8 m
Weight:	4.7 kg	8 kg	12 kg



Counter Weight

Code: 20cw
Weight: 20.0 kg



*Pictures are for illustrative purpose only, weight of product may vary.

Visit www.turboscaffolding.com.au

Scaffold Accessories & Specials

Available in Painted & Galvanised Finish



Timber Planks - 230 x 38 mm

Code:	1.2m	1.5m	1.8m	2.4m	3.0m	3.6m
Size:	230 x 38 mm	230 x 38 mm	230 x 38 mm	230 x 38 mm	230 x 38 mm	230 x 38 mm
Weight:	6.6 kg	8.25 kg	9.9 kg	13.2 kg	16.5 kg	19.8 kg



*Other sizes may be available

Lap Panels

Code:	0.5MLP	0.7MLP
Size:	0.5 m (2 board wide)	0.7 m (3 board wide)
Weight:	7.5 kg	9.5 kg

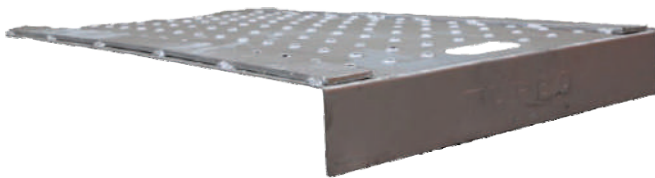

1.2m Return Transoms

Code:	1.2MGRETRN
Size:	1.2 m
Weight:	14.2 kg



Ledger Truss

Code:	1.2MLT	1.8MLT	2.4MLT
Size:	1.2 m	1.8 m	2.4 m
Weight:	19 kg	31.5 kg	42 kg



Ladder Beams

Code:	3.0MLB	4.8MLB	5.4MLB	6.3MGLB
Size:	3.0 m	4.8 m	5.4 m	6.3 m
Weight:	34.5 kg	54.43 kg	64 kg	74 kg

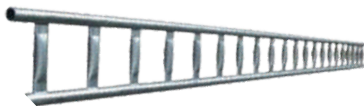

Stair Stringers

Code:	1.6MSS	3.0MSS
Size:	1.2 x 1.0 m	2.4 x 2.0 m
Weight:	34 kg	65 kg

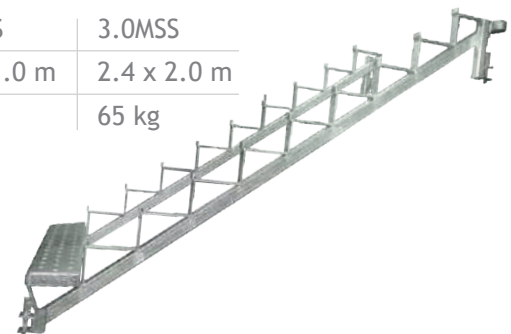

Unit Beam

Code:	3.6MUB
Size:	3.6 m
Weight:	42 kg



Bridging Ledgers with Spigot

Code:	3.6MGBLSP	4.8MGBLSP
Size:	3.6 m	4.8 m
Weight:	22 kg	26.5 kg



*Pictures are for illustrative purpose only, weight of product may vary.

Visit www.turboscaffolding.com.au

Scaffold Accessories & Specials

Available in Painted & Galvanised Finish



Handrail Posts

Code: HRP
Size: 1.2 m
Weight: 6 kg



Wall Tie Brackets

Code: WTB
Size: 100 x 250 m
Weight: 2.8 kg

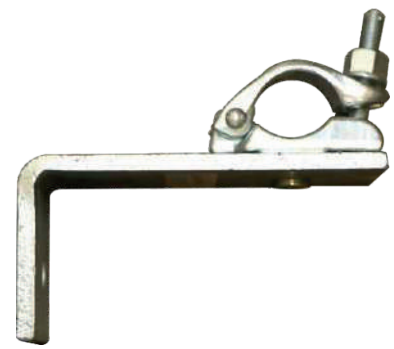

* Also available with 2 fittings

200mm Castors

Code: CW
Size: 200 x 50
Weight: 6 kg

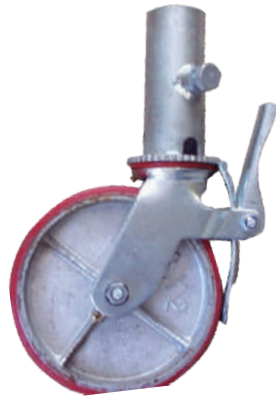

Scaffolding Tag Box

Code: STBI
Weight: 2.5 kg

* 10 Tags, 20 Inserts and 2 Pens per box



Step Up Brackets

Code: SDB
Size: 1 Board
Weight: 4.2 kg

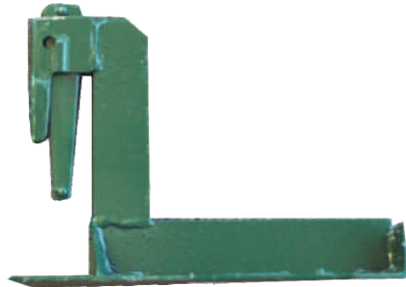

Step Down Bracket Intermediate Galvanised

Code: GSDBCPLR
Size: 1 Board
Weight: 4.2 kg

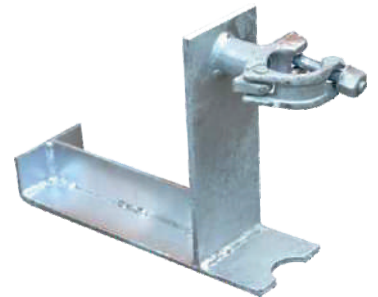

Double Step Down Bracket

Code: DSDB
Size: 1 Board
Weight: 6.5 kg



*Pictures are for illustrative purpose only, weight of product may vary.

Visit www.turboscaffolding.com.au